

OPERATING, FIELD MAINTENANCE, AND PARTS MANUAL



**MODEL
975**



BEFORE OPERATING, ATTACH UL GUARD (PART NUMBER 41)

GENERAL SAFETY PRECAUTIONS

Never point the gun at anyone

Inspect hose before each use for breaks or weakened spots.

Always shut off valve at tank when leaving the gun unattended for any length of time.

WARNING: DO NOT TOUCH PERFORATED METAL SHIELD AFTER GUN HAS BEEN FIRED.

TABLE of CONTENTS

- I. INTRODUCTION
- II. WHICH BAG TO BUY
- III. WHICH TANK TO USE
- IV. VENTILATION REQUIREMENTS
- V. OPERATING INSTRUCTIONS
 - A. CONTROLS
 - B. CONNECTIONS
 - C. START-UP
 - D. HOW TO SHRINK
 1. PALLETS
 2. PATCHING
 3. LARGE GOODS
- VI. SERVICE INFORMATION
 - A. PRINCIPLES OF OPERATION
 - B. TROUBLESHOOTING
 - C. ASSEMBLY AND DISASSEMBLY
 - D. TECHNICAL SPECIFICATIONS
 - E. PARTS BREAKDOWN & SPARE PARTS.

I. INTRODUCTION

The New Shrinkfast Model 975 heat shrink gun has evolved from the previous model 305X as a consequence of thousands of units sold in over 25 countries. The major new features include a safety handle which will automatically shut the gun off if it should be dropped and simplified construction which allows almost any malfunction to be corrected in the field.

The manual has also evolved into a simplified format which if read carefully will greatly enhance the operator's skill in using the tool. In addition, every operator should be particularly aware of the safety requirements covered in Section III WHICH TANK TO USE and Section IV VENTILATION REQUIREMENTS.

II. WHICH BAG to BUY

Bag makers can usually be found in the Yellow Pages under Packaging Supply Houses or Bags — Transparent. Salesmen are generally knowledgeable and can give you good advice, but you should keep the following facts in mind:

1. Not all plastic bags are shrink bags; therefore, be specific. Shrink film should always be made of virgin plastic, not reprocessed material.
2. Bags come in various thicknesses. The bag thickness is measured in mils. The most common is 5 mil. For light loads such as a load of cookies at 100 lbs./pallet a 3 mil bag should be satisfactory. However, drums of molasses, for example, at 2000 lbs./pallet would require 6 mils or more.
3. Bags are made in two styles, centerfold and gusseted. Gusseted bags shrink equally in both directions (35%/45%) and are troublesome because they tend to pull up and away from the pallet. Therefore, they should be bought longer than the pallet height, and special care should be taken in the bottom shrink. Centerfold bags shrink mostly in one direction around the pallet (60%/10%); therefore they don't have a tendency to pull up off the pallet.
4. Bag dimensions are specified by lay-flat length and width. Example:

To calculate the width; add:

1.	The two sides	30"
		47"
		<hr/>
		77"
2.	Fitting allowance	4"
		<hr/>
	WIDTH	81"

To calculate the length; add:

1.	1/2 of the short side	15"
2.	The height	36"
3.	Shrink allowance – 1" for each foot of height	3"
		<hr/>
	LENGTH	54"

IN THIS CASE THE BAG SIZE IS 81" x 54".

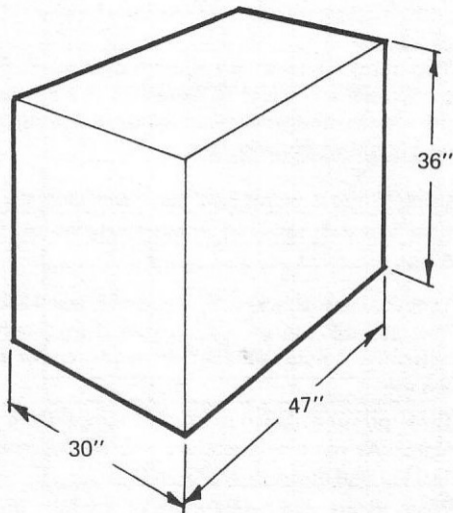

III. WHICH TANK to USE

Two types of tanks are commonly available: liquid withdrawal and vapor withdrawal. It is crucial to use the vapor withdrawal type. Never try to run the gun on a liquid withdrawal tank.

Using a liquid withdrawal tank will clog the orifice filter and may result in an extremely dangerous long flame.

Tanks are available in 6, 8, 10, 20, 30, and 40 lb. sizes. The gun will run on a 6 lb. tank if used only intermittently. Larger tanks should be chosen for continuous use.

Tank pressure depends on the temperature of the tank. At room temperature (72°F) the pressure is 110 PSI and drops to 22 PSI at 0°F.

When in use, the temperature of the tank drops due to the evaporation process of liquid propane to propane gas.

After prolonged use the temperature of the tank may drop to 0°F usually accompanied by icing on the outside, and the propane pressure drops below 22 PSI. DO NOT RUN THE GUN WITH THE PRESSURE BELOW 22 PSI.

Small or nearly empty tanks ice up faster than large, full tanks. Typically, a full 30 lb. tank if run continuously will run 90 minutes before it ices up. If the production rates demand continuous use the following methods may be employed:

1. Multiple tanks. Switch the gun from one tank to another.
2. Fan. An ordinary desk fan at the tank. The air flow around the tank will keep it from icing up.



RIGHT: Vapor Withdrawal Tank commonly used for plumbers torches, welding and cutting apparatus and camp and trailer stoves.

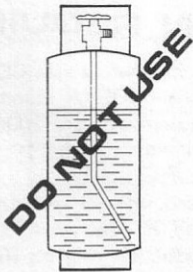

WRONG: Liquid Withdrawal Tank commonly used for Lift Truck or other internal combustion engines.

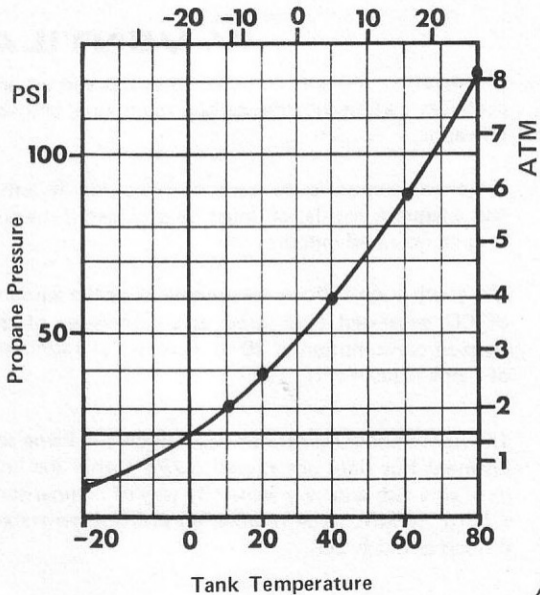

IV. VENTILATION REQUIREMENTS

In operation the gun consumes propane and air and produces carbon dioxide, carbon monoxide, and water vapor.

Prolonged exposure to carbon monoxide is lethal and adequate ventilation must be provided if the gun is to be operated indoors.

The graph (right) shows measurements of the amount of CO generated (expressed as a percentage of the fresh air consumption of 20 cu. ft./min.) as a function of flame adjustment:

The amount of CO generated depends on the flame adjustment but does not exceed 0.25% within the limits of very rich and very lean. (By way of comparison, a 35HP forklift truck running on propane generated 6 times as much CO).

To maintain a safe CO concentration of 50 parts per million (OSHA standards 1910.93) the ventilation requirements are 1000 cu.ft./min. while the gun is running.

Based on a 3 minute heating cycle per pallet, the fresh air requirements are 3000 cu.ft./pallet. For a production rate of 10 pallets/hour a ventilation system with a continuous capacity of 500 cu.ft./min. is adequate. For different production rates the ventilation capacity should be sized proportionally.

In areas where ventilation is provided by open doors or windows, a safe level of CO will be maintained as long as the room temperature does not rise above 150°F.

Carbon Monoxide, %

0.3

0.2

0.1

80

100

120

Flame Adjustment, % of stoichiometric

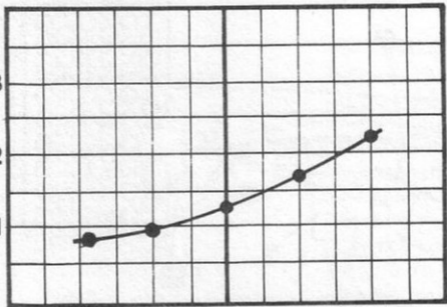

V. OPERATING INSTRUCTIONS

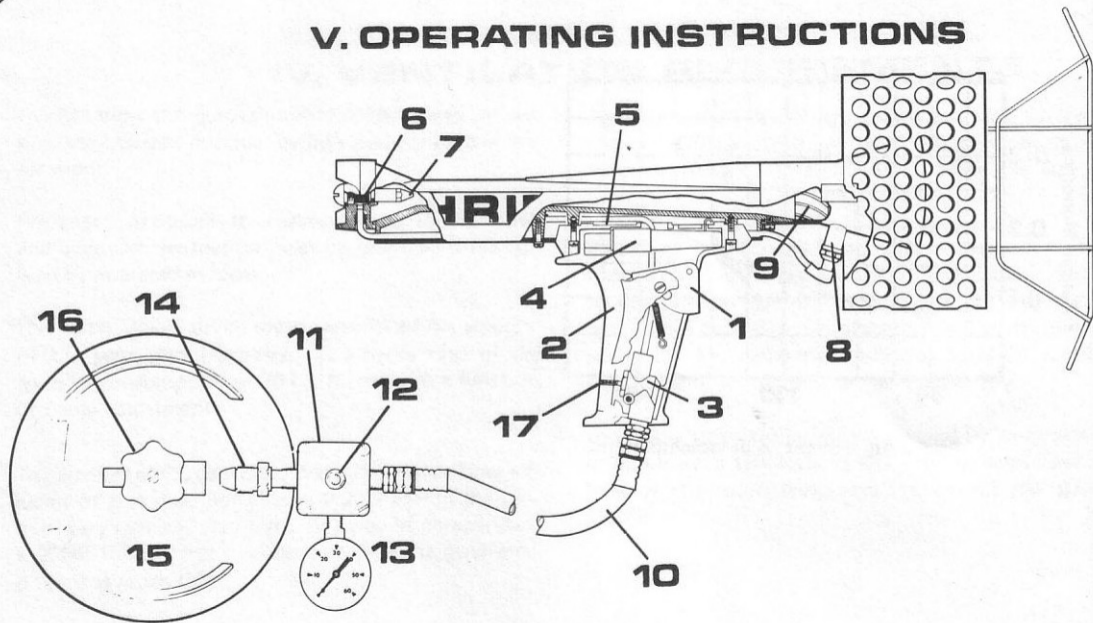

A. CONTROLS

No.	PART	FUNCTION
1	SAFETY TRIGGER	PREVENTS ACCIDENTAL GAS RELEASE
2	GAS HANDLE	ACTUATES GAS VALVE AND IGNITER
3	GAS VALVE	OPEN FUEL FLOW
4	IGNITER	FIRES PIEZOELECTRIC SPARK IGNITER
5	FUEL LINE	CARRIES FUEL TO ORIFICE
6	FILTER	PREVENTS CLOGGING
7	ORIFICE	METERS FUEL
8	SPARK PLUG	IGNITES MIXTURE
9	FLAME HOLDER	PREVENTS FLASHBACK AND FLAME OUT
10	HOSE	CONNECTS REGULATOR & GUN
11	REGULATOR	REGULATES PRESSURE TO GUN
12	ADJUSTMENT SCREW	SETS PRESSURE
13	PRESSURE GAUGE	INDICATES PRESSURE IN THE LINE
14	FITTING	CONNECTS & CONTAINS EXCESS FLOW CHECK VALVE
15	TANK	SEE SECTION ON TANK
16	TANK VALVE	OPENS/CLOSES FUEL SUPPLY
17	ADJUSTMENT SCREW	ADJUSTS VALVE TIMING

FOR ORDERING OF SPARE PARTS SEE PAGE 26 AND 27.

B. CONNECTIONS

Connect the gun, hose and regulator to the tank using a wrench to tighten the fittings which all have left hand threads.

To check for leaks, open the tank valve without actuating the gun handle to pressurize the hose. The pressure gauge should read approximately 24 PSI when the gun is not in use. Then close the tank valve and observe the pressure gauge. A rapid loss of pressure indicates a leak. Check all connections.

UL guard must be attached before operating gun. Attach wire UL guard to the front opening of the combustor using screws and lock washers supplied. (see cover photo for actual installation)

C. START-UP

After all connections are made and checked for leaks the gun is ready for use. Open the tank valve. Wait approximately 5 seconds to fully pressurize the hose or until the excess flow check valve opens with an audible click.

To start the gun first press the safety trigger which prevents the gas handle from being accidentally opened. Then squeeze the gas handle slowly all the way until the igniter fires with an audible click. **CAUTION, GUN WILL IGNITE.**

NOTES:

1. It is important to squeeze the gas handle slowly. If the gas handle is squeezed too quickly the igniter will fire the spark plug before the gas mixture gets there.
2. Should the gun fail to fire fully, release both safety trigger and gas handle fully to assure that the igniter is reset and repeat the starting procedure.

D. HOW TO SHRINK

1. PALLETIZING

Your SHRINKFAST gun consumes oxygen and must be used only in well ventilated areas. **WARNING: DO NOT OPERATE GUN IN AREAS WITH FLAMMABLE GASSES OR WHERE SMOKING IS PROHIBITED.**

- a. Elevate the pallet load approximately 6 inches from the floor, leaving the under sides of the four corners unobstructed.
- b. Fit the pallet bag over the load, taking care that the film is not punctured as it is pulled into place. The bag should fit snugly over the goods and overhang the base of the pallet almost to the floor.
- c. To bottom shrink ignite the gun and hold it approximately 12" from the film surface. Move once around the pallet applying heat to the bottom edge of the bag and using the air velocity to blow it under the pallet. Shrink it so that it grasps the underside of the pallet firmly. In so doing the bag is locked to the pallet thereby unitizing the load.
- d. To side shrink do one side after another. Hold the gun approximately 12" from the film surface; shrink the side by sweeping the gun smoothly across the bottom. Move up a foot and sweep back and continue sweeping

(continued)

across the face moving up with every sweep until the side is finished. You will see the film wrinkling ahead of the gun as the film behind commences to shrink. It is important that the gun be kept in motion at all times. The action is very similar to spray painting.

As one side is completed move to the next each time commencing at the bottom and working your way up as you sweep from side to side.

- e. The top of the pallet is shrunk last and requires less heat than the sides. This is due to it already having been pulled taut through shrinkage of the four sides.
- f. The pallet is now ready for shipment. Lift truck forks may be driven through the film where it covers the wooden pallet; the punctures will not propagate.

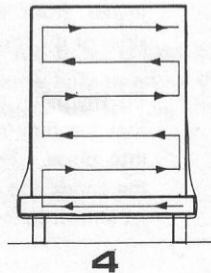
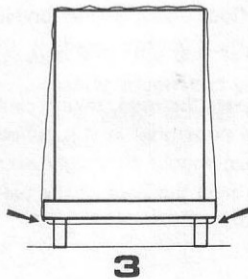
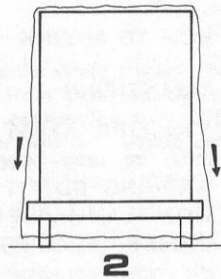
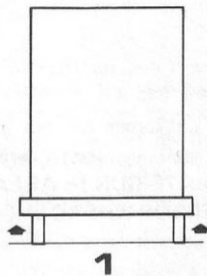

NOTES:

1. The most important fact to keep in mind is that heat only softens the film. The greatest amount of shrinking occurs as the film cools. It is a common fault of the inexperienced operator to apply too much heat to the film often concentrating the heat and waiting for the film to shrink before moving the gun.

Keep the gun moving.

With a little practice you will find you can hold the gun closer to the film and sweep faster often shrinking a pallet in less than 2 minutes.

2. It is absolutely necessary that the four corners of the bag be caught under the pallet. If this is not done the effectiveness of shrink palletizing is considerably reduced.

2. PATCHING

Occasionally holes will appear in the film. These may be easily patched by laying a square of film over the hole and applying heat around the edges, thereby welding the patch to the bag. The same technique may be applied to reinforce edges or corners with patches.

3. SHRINK WRAPPING LARGE OR ODD SHAPED LOADS

Shrink wrapping is a versatile method which may be employed in a great variety of applications. For example, shrink wrappers routinely wrap irregular objects such as canoes using sheets of shrink film.

Objects which are too big to fit under a bag may be wrapped by using several sheets of shrink film joined together if the following two precautions are observed:

[continued]

- a. Adjoining sheets should have an 18" overlap. This overlapping allows the sheets to weld together during the shrink process.

- b. The sheets must be secured at the base of the load using the weight of the load or by battens tacked to the skids or any other method that may be expedient.

NOTE: SHEETS SHOULD BE JOINED TOGETHER ON THE FLOOR WITH AN 18" OVERLAP

VI. SERVICE INFORMATION

Note: Letters Keyed To Text On Following Pages.

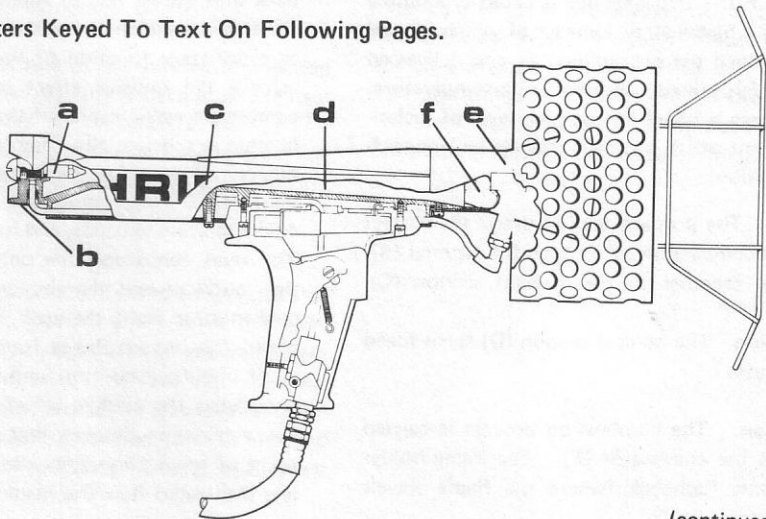

(continued)

A. PRINCIPLES OF OPERATION

The SHRINKFAST 975 heat gun is basically a simple jet engine, the high-energy exhaust of which is used to pump and heat the surrounding air and deliver an air blast of high velocity and moderate temperature. Its effectiveness is based on the high level of technical development which has gone into optimizing each stage of operation:

1. Jet Pump. The propane jet (A) draws the correct amount of combustion air through the air inlet (B). They mix together in the straight section (C).
2. Compression. The conical section (D) turns speed into pressure.
3. Combustion. The combustion process is carried out inside the combustor (E). The flame holder (F) prevents flashback (where the flame travels

back into the jet pump) and the flame out (where the flame is blown out of the combustor). Another proprietary function of the flame holder is to achieve the unusual effect of maintaining cold combustor walls in spite of the fact that the combustion is substantially completed inside the combustor. This it does by imparting a swirl to the mixture. During combustion, the burned portion of the mixture expands, and its density diminishes. The swirl centrifuges the unburned, heavier portion outward and thereby creating a blanket of cold mixture along the walls. As combustion proceeds, the process draws from the protective layer of unburned mixture, and when combustion is completed the cooling effect stops. The size of the combustor ensures that for rated flow the point of completion coincides with the outlet. At less than rated flow the blanket of unburned mix-

ture does not extend all the way to the outlet and results in a red hot combustor outlet.

4. Expansion. By virtue of the internal combustion process at elevated pressure a portion of the heat energy is converted to exhaust gas velocity. The gases are expanded into the atmosphere through the combustor (E) with a velocity of over 160 MPH and a noticeable amount of thrust.

5. Entrainment. A second jet pump effect is created by the exhaust gases as they leave the combustor. The slot shaped outlet of the combustor creates a large mixture interface and promotes high volume entrainment within an unusually short distance. The exhaust gases transfer their heat and momentum to the entrained air and thus create

a stream of high volume, low temperature air. This pumping effect is progressive, i.e. as the distance from the combustor increases so does the volume of air entrained. Since the heat and momentum are distributed over all the entrained air, the temperature and velocity of the output decrease as a function of distance away from the gun.

B. TROUBLESHOOTING GUIDE

The majority of the problems arise from using a liquid withdrawal instead of a vapor withdrawal tank. CHECK THIS ITEM FIRST.

PROBLEM

GUN WON'T FIRE

PROBABLE CAUSE

Handle not depressed fully.

Handle activated too quickly.

Pressure too low.

Handle not released fully.

Spark plug gap too small.

Defective igniter or connections.

Gas not on.

REMEDY

Depress handle all the way until igniter fires with a click.

Squeeze handle slowly to make sure mixture has entered combustor before firing.

Check Regulator.

Release both triggers to make sure igniter is reset.

Open gap to 3 mm.

Check for spark. Return for service.

Check ON/OFF valve.

PROBLEM

PROBABLE CAUSE

REMEDY

COMBUSTOR
TURNS RED* —
(INSUFFICIENT
FUEL FLOW)

Wrong fuel.

Tank has iced up and tank
pressure is below 22 PSIG.

Excess flow check valve not
open.

Clogged orifice and/or filter

Clogged hose.

Clogged fuel line.

Check for proper type.

Change to new tank .

Open tank valve and wait 10 secs.
until hose is pressurized before using
gun.

Remove and clean with compressed air.

Blow out or replace.

Blow out or replace.

LARGE FLAME
(TOO MUCH FUEL
FLOW)

Leak in orifice assembly.

Wrong pressure.

Tighten orifice in holder and check.

Reset to 22 PSIG.

* Leading edge of combustor will turn red under normal conditions. If more than 1" of combustor turns red trouble is indicated.

C. ASSEMBLY & DISASSEMBLY

GENERAL NOTES

1. Grease all "O" rings to facilitate assembly.
2. Fitting (23) is glued permanently into the valve body (22).

1.0 ORIFICE CLEANING

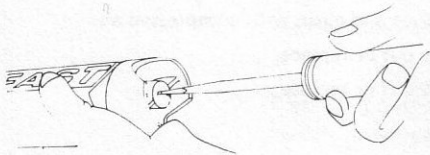

- 1.1 Unscrew orifice holder (1) using a screw driver or a coin.

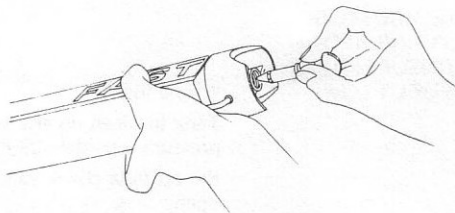

- 1.2 Pull out orifice assembly.

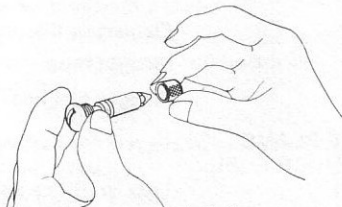

- 1.3 Slip out filter screen (3).
- 1.4 To clean the filter and the orifice (5) blow out with compressed air. Damaged orifice must be replaced.

2.0 HANDLE ASSEMBLY

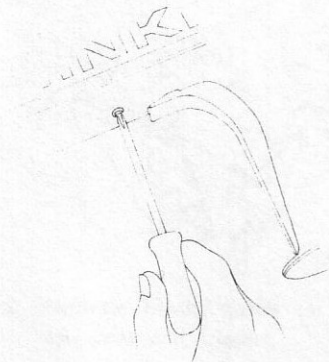

2.1 Undo screw (14) holding bracket (12).

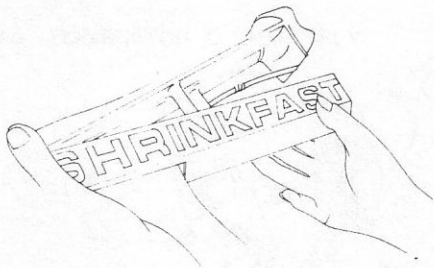

2.2 Remove bracket by pulling it away and tilting it to clear the end of the handle.

Note: Numbers Refer To Parts Shown On Page 26

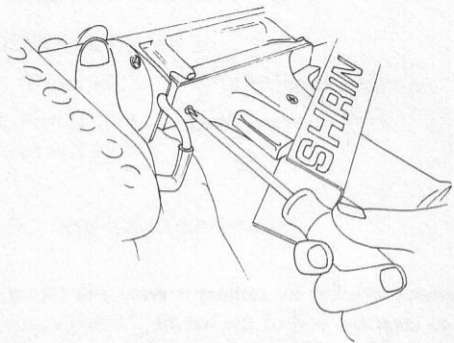

2.3 Remove front and rear screws (19) holding handle. To reach the rear screw gas handle (17A) must be depressed fully.

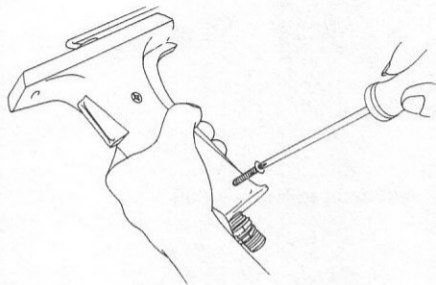

2.4 Unclip spark plug lead (26A) and pull gas line (9) out of bushing. Handle assembly can now be removed. Undo handle screws (15).

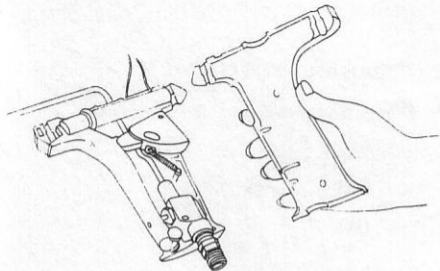

- 2.5 Separate handle halves for access to igniter gas valve and triggers.

3.0 COMBUSTOR DISASSEMBLY

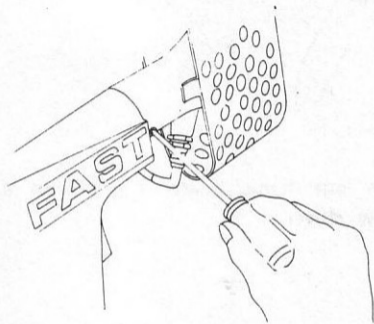

- 3.1 Undo spark plug clip (26A) undo screws (31) holding combustor and pull combustor off the body by twisting it.

(continued)

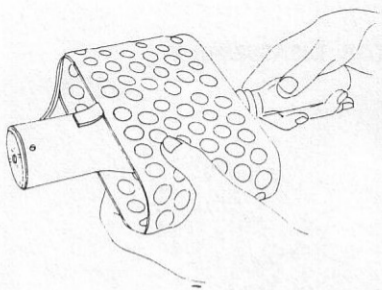

3.2 Push out flame holder (32) with a long screw driver.



3.3 **IMPORTANT:** Flame holder (32) side with hole must face orifice end.

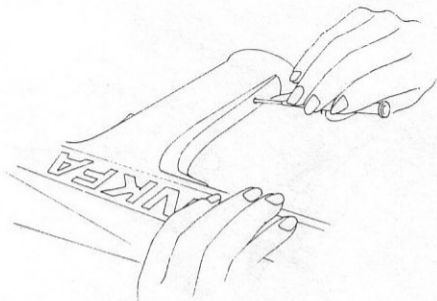

4.0 VALVE TIMING ADJUSTMENT

Gas valve opening is adjusted by the adjustment screw (16).

It should be set so that the valve opens when the gas handle is depressed half way.

D. TECHNICAL SPECIFICATIONS

OUTPUT CHARACTERISTICS

Distance/Ft.	Temperature/°F	Velocity - Ft./Min.
1/2	1200	2800
1	750	1700
2	450	800

Heat Capacity	125,000 Btu./Hr.
Propane Consumption	5.7 Lbs./Hr.
Operating Pressure	22 PSIG
Weight	3 Lbs. 3 Oz.
Air Consumption	21 CFM
Emission.017 CO/CO ₂

E. PARTS BREAKDOWN & SPARE PARTS

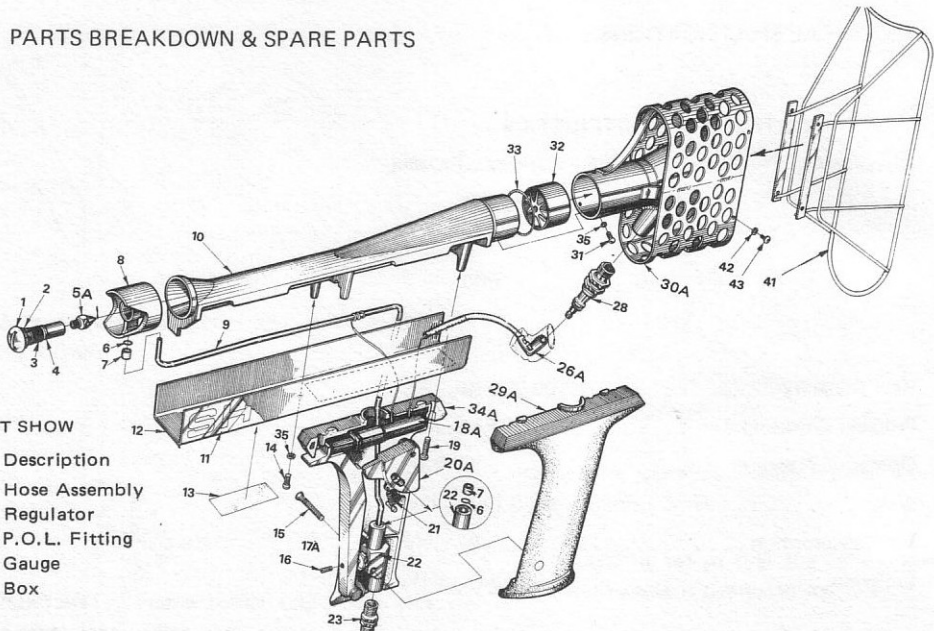

ITEMS NOT SHOW

Key	Description
36	Hose Assembly
37	Regulator
38-1	P.O.L. Fitting
39	Gauge
40	Box

E. PARTS BREAKDOWN & SPARE PARTS

Key	Description	Key	Description
1	Orifice Holder	21	Spring
2*	"O" Ring	22*	Valve Assem.
3*	Filter	23	Hose Adapter
4*	"O" Ring	26A	UL Boot & Connector
5A	Orifice	28	Spark Plug
6*	"O" Ring	29A	Handle - R.S.
7	Retainer	30A	Combustor
8	Inlet	31	Rd. Hd. Phil. Scr.
9	Fuel Line	32*	Flame Holder
10	Body	33*	"O" Ring
11	Label	34A	Handle - L.S.
12	Channel	35	Lock Washer
13	Serial No. Label	36	Hose Assembly
14	Rd. Hd. Phil. Scr.	37	Regulator
15	Flat Hd. Phil. Hd. Scr.	38-1	P.O.L. Fitting
16	Slot Set. Scr.	39	Gauge
17A	Trigger	40	Box
18A	Igniter	41	UL Guard
19	Rd. Hd. Phil. Hd. Scr.	42	Washer
20A	Safety	43	Screw

*Suggested Spare Parts

SHRINKFAST

WORLD LEADERS IN SHRINKWRAPPING



SHRINKFAST MARKETING

460 Sunapee Street, Newport, New Hampshire 03773
Tel. 603-863-7719 FAX 603-863-6225

© 1975 Gloucester Engineering Co., Inc.
Revised 2-23-87